



TEAPORT[®]

Professional
Tea Machine

www.teaport.com.tr



Always Tea!

Teaport is designed with the purpose of providing proper, hygienic, always hot, quality tea in companies, institutions and facilities. Teaport can steep tea in different quantities with different models and it always provides fresh tea to employees and guests of companies and facilities in intended quantities. Teaport is the unique machine in its category with this specification.

With Teaport, you can prepare hundreds even thousands of glasses of tea with only one touch. Further, your tea stays fresh during the day.

How would like to drink your tea?

✓ **Economical**

Teaport saves up 50% dry tea quantity for getting steeped tea in same quantity.

- It provides big energy savings (electric and gas) when preparing same quantity of tea.
- It removes lost time and waste during steeping process completely.
- As the tea stays fresh for 12 hours, it prevents the dry tea waste issue and removes the necessity of adding new tea in different times of day.
- It removes all costs like workforce for cleaning, chemicals, water waste completely.

👍 **50%**
economical

✓ **Fresh**

Teaport brings an end to the sentences, which you often hear during the day like 'Tea has not steeped yet, Tea is not fresh, Tea is finished'. Your tea is always fresh with Teaport.

🌿 **12**
hours
fresh

✓ **Efficient**

- Only one employee can steep thousands of glasses of tea with Teaport.
- It provides quality tea, time and workforce efficiency by covering the necessity of whole day with only one steeping.
- It removes frequently encountered work accidents in usual steeping processes.
- It raises satisfaction of employees and guests by removing all confusion of tea department.



✓ Hygienic and Natural

Teaport fundamental idea states that health is more important than everything. So it cleans itself with completely natural blends. Teaport is inline with food standards with its stainless steel boiler and installation system. With its stated specifications, you don't feel any chemicals and drink a more healthy tea.



✓ Safety

Via 7 security softwares and hardwares, Teaport removes all risks like gas leakage.



✓ Bright Red Or Weak Tea..
Final Is For Your Profit..

Teaport 500



- 12 hours fresh tea
- 60 minutes steeping time
- It is made with flue or flueless according to project.
- If any power cut occurs, Teaport stops, when power starts, Teaport continues to working from last process.
- Tap pieces: 2
- Water capacity: 50 lt.

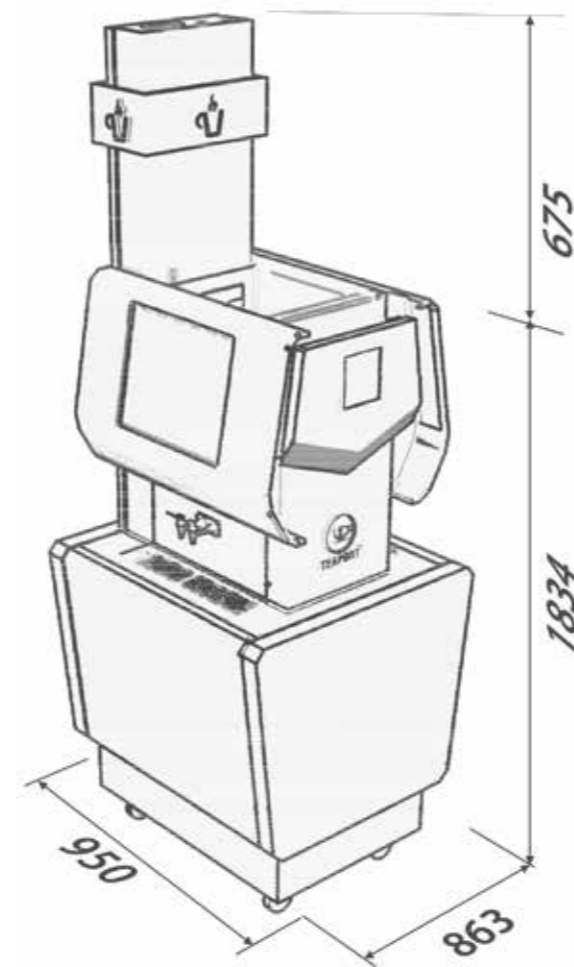

12 Hours
Freshness



Programming
For Future
Times

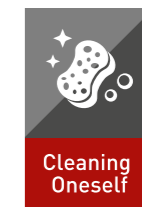

Cleaning
Oneself

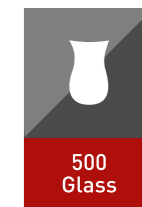

500
Glass

Teaport 1000



- 12 hours fresh tea
- Steeping time 80 minutes in electrical model, 60 minutes in gas-filled model
- If any power or gas cut occurs, Teaport stops, when power or gas starts, Teaport continues to working from last process.
- Tap pieces: 4
- Water capacity: 100 lt.

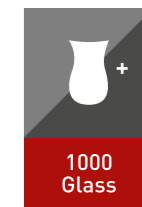
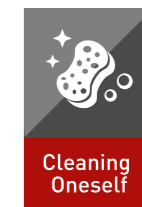
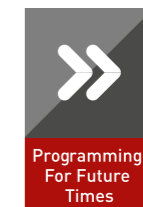
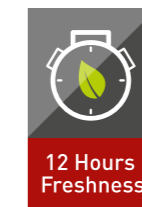
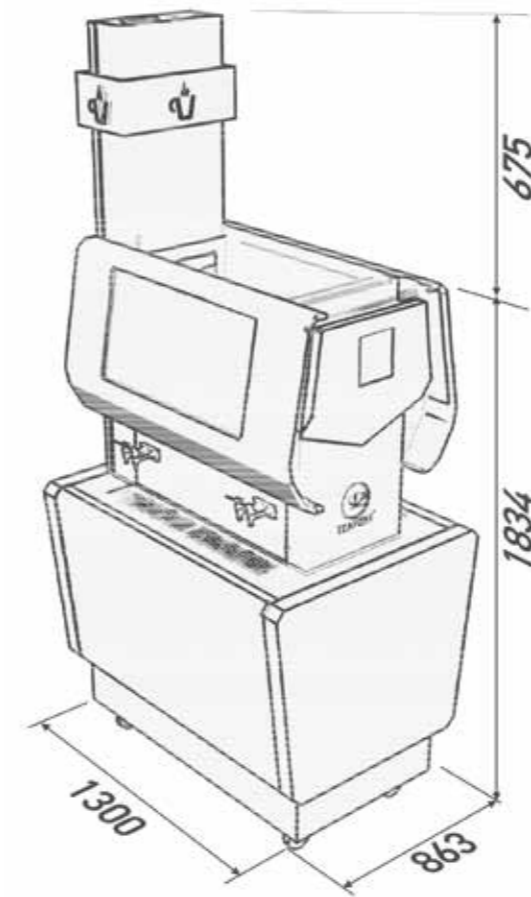

Teaport 2000



- 12 hours fresh tea
- steeping time 120 minutes in electrical model, 80 minutes in gas-filled model
- If any power or gas cut occurs, Teaport stops, when power or gas starts, Teaport continues to working from last process.
- Tap pieces: 4
- Water capacity: 200 lt.

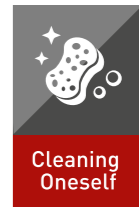
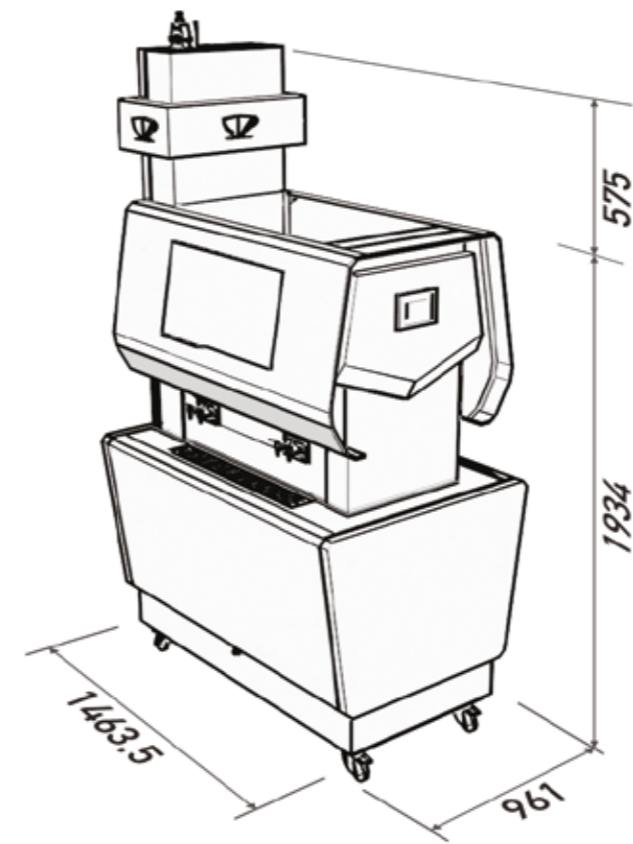

Teaport 4000



- 12 hours fresh tea

- Steeping time 240 minutes in electrical model, 140 minutes in gas-filled model
- If any power or gas cut occurs, Teaport stops, when power or gas starts, Teaport continues to working from last process.
- Tap pieces: 6
- Water capacity: 400 lt.

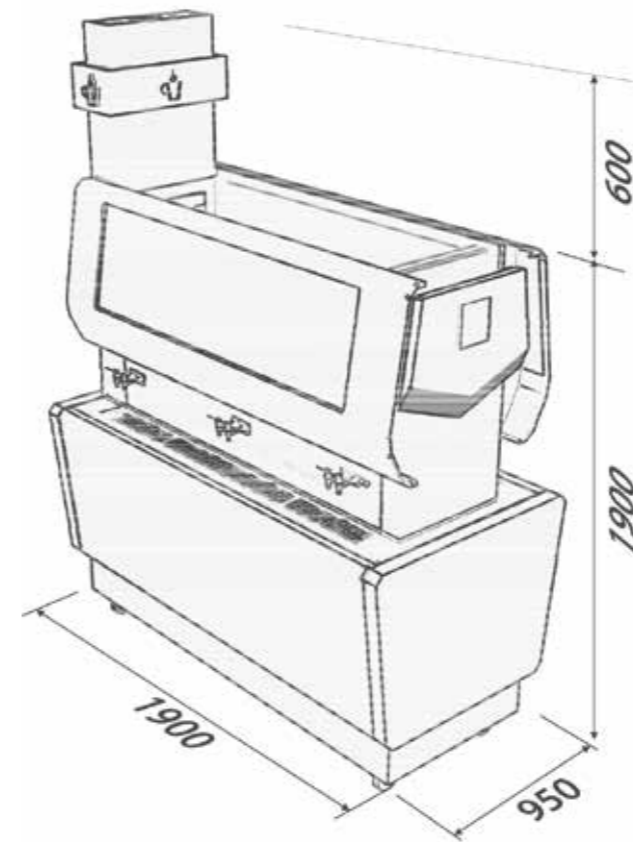

12 Hours
Freshness

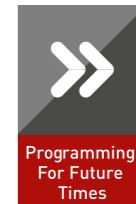

Programming
For Future
Times

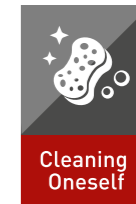

Cleaning
Oneself

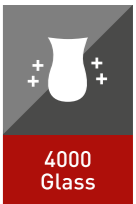

4000
Glass

Teaport 5000



- 12 hours fresh tea
- Steeping time 300 minutes in electrical model, 175 minutes in gas-filled model
- If any power or gas cut occurs, Teaport stops, when power or gas starts, Teaport continues to working from last process.
- Tap pieces: 6
- Water capacity: 500 lt.

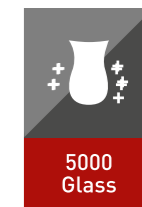
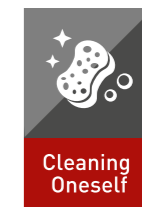
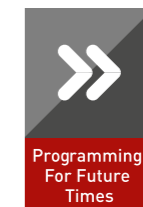
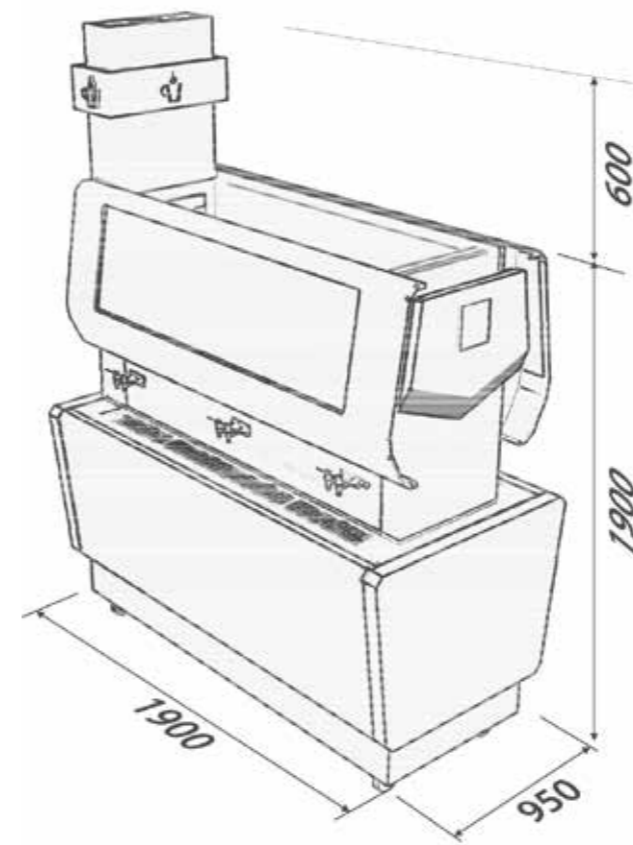

Areas of usage

Tea here, there and everywhere... Tea for you, her and everyone...

Thinking of any moment without tea is impossible in our country, like your office, school, entertainment, free time, after lunch or dinner and all areas which you can imagine. So we are working for this irreplaceable pleasure.. Tea, here, there and everywhere.

Military Units

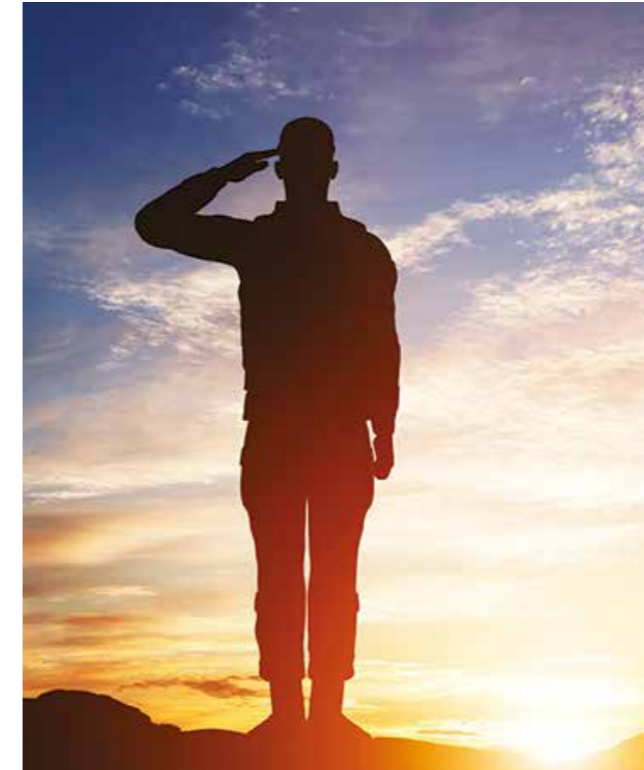

Hazardous areas



5 stars hotels, holiday villages and conference rooms

Big industrial enterprises, government offices (municipalities, tax offices)



Stadiums, sport halls



Road side restaurants





Festival and concert areas



Tea gardens



Fair areas



Ship ladders, ships



Boarding schools, military schools, canteens, university canteens, cafeterias and student residences



Tea Preparing System

Teaport tea preparing system has its own and high quality technology equipment and it is designed for perfectly preparing tea of your company and facility. All steeping process is systematized with technological equipments so as to prepare the tea as per your taste. User interface in remote control panel is designed for all employees. It is easily to operate

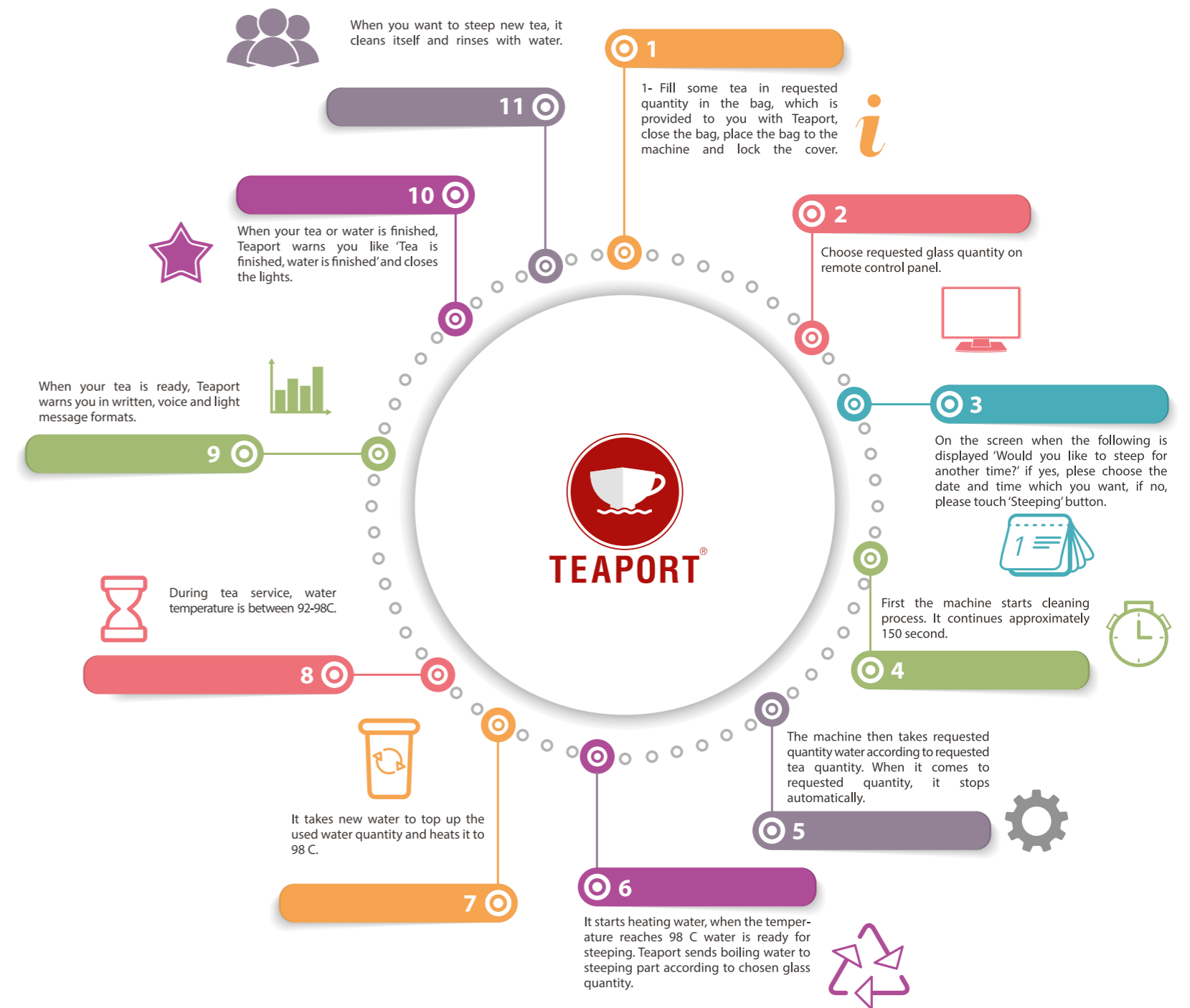

	Teaport 500	Teaport 1000	Teaport 2000	Teaport 4000	Teaport 5000
Only preparing hot water specification	✓	✓	✓	✓	✓
Cleaning specification oneself	✓	✓	✓	✓	✓
Movement ability (braked and wheeled)	✓	✓	✓	✓	✓
Programming for future times	✓	✓	✓	✓	✓
Touch-operated buttons-touch screen	✓	✓	✓	✓	✓
'Tea ready' warning system	✓	✓	✓	✓	✓
No water overflowing system	✓	✓	✓	✓	✓
City water manometer	✓	✓	✓	✓	✓
City water clean up system	✓	✓	✓	✓	✓
Gas security	No (Works with electricity)	✓	✓	✓	✓
Energy type	380 V Electricity	380 V Electricity/Natural gas	380 V Electricity/Natural gas	380 V Electricity/Natural gas	380 V Electricity/Natural gas
Water usage	City water / Manuel	City water / Manuel	City water / Manuel	City water / Manuel	City water / Manuel
Glass number (100 ml)	500 pieces	1000 pieces	2000 pieces	4000 pieces	5000 pieces
Glass capacity	100 ml	100 ml	100 ml	100 ml	100 ml
Usage type	Automatic / Manuel	Automatic / Manuel	Automatic / Manuel	Automatic / Manuel	Automatic / Manuel
Certificate of conformity	CE-TSE	CE-TSE	CE-TSE	CE-TSE	CE-TSE
Guarantee period	2 Years	2 Years	2 Years	2 Years	2 Years
Amount of using dry tea (gr)	500	1000	2000	4000	5000
Electricity consumption(kW)	5	10	20	40	50
Natural gas consumption (m ³)	It Works only with electricity	1,65 m ³	3,3 m ³	6,6m ³	8,25 m ³

Asistant Equipments

Steeping Bag

- Proper to food standard
- %100 cotton
- Proper to 500 gr or 1 kg dry tea
- Sewed and laced bags.



Dry tea measuring device

- Proper to food standard
- %100 stainless
- 500 gr dry tea measuring device



Cleaning kit

- %100 natural
- Doesn't contain any chemicals
- Proper to cleaning of boiling part of machine and installation part
- It solves calcs and other leavings
- It occurs from natural blends



Granulated sugar bowl

- Aluminium light trunk
- Electrostatik oven drying
- 6 pieces granulated sugar bowl with 5,5 lt capacity
- Lower tray with grat surface
- 4800 glass storage area
- 2000 glass capacity
- Little dustbin for blender etc.
- Blender service area

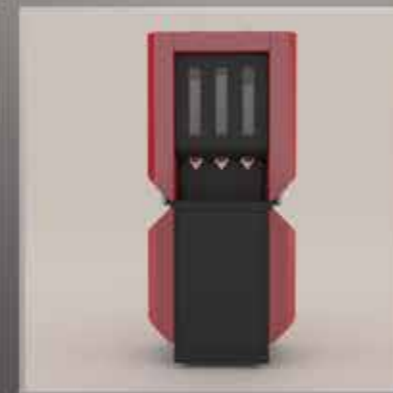
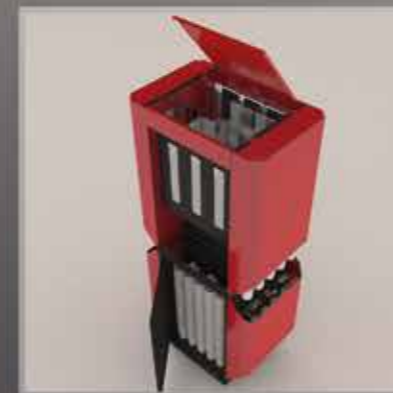

Stick sugar bowl

- Aluminium light trunk
- Electrostatic oven drying
- 1900 glass glass capacity
- Herbal tea part
- Blender part
- Dustbin for blender etc.
- 2000 pieces stick sugar part

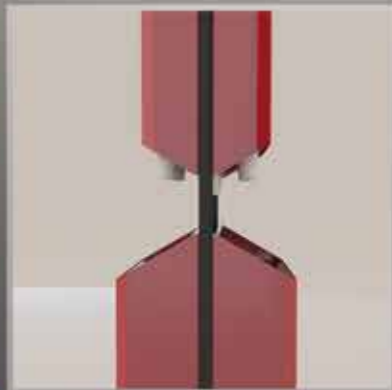

Teaport glass unit

- With base or non base production as per request
- Stainless and steel trunk
- 288 pieces tea glass, 130 pieces cups, 430 pieces glass/cup coaster capacity
- Consumable material shelved storage area for with base model
- Double sized dustbin over trunk for with base model



Mobile water supply tank

- It is produced in proper sizes according to machine model
- Waste water + clean water or only clean water usage
- Stainless tank and steel trunk
- Waste water and clean water delivery valve
- Automatic water transfer pump
- Level determination sensor

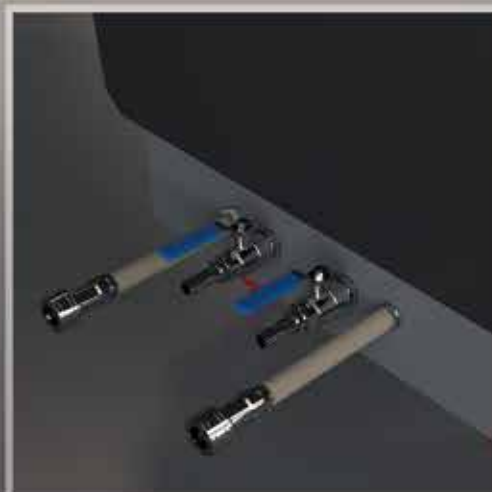
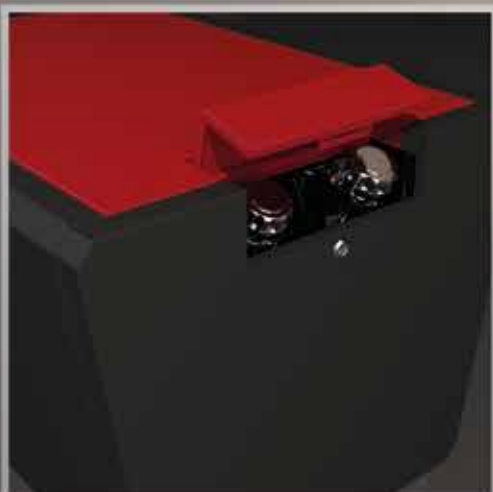

www.teaport.com.tr



TEAPORT

Ferhatpaşa Mah. Gazipaşa Cad. 51. Sok. No: 39 Ataşehir / İstanbul / TURKEY
T: +90 216 314 42 43 F: +90 216 314 42 03
info@teaport.com.tr